

# David Jones

TIC Retail Accessories

## Garment Hanger Ordering Manual

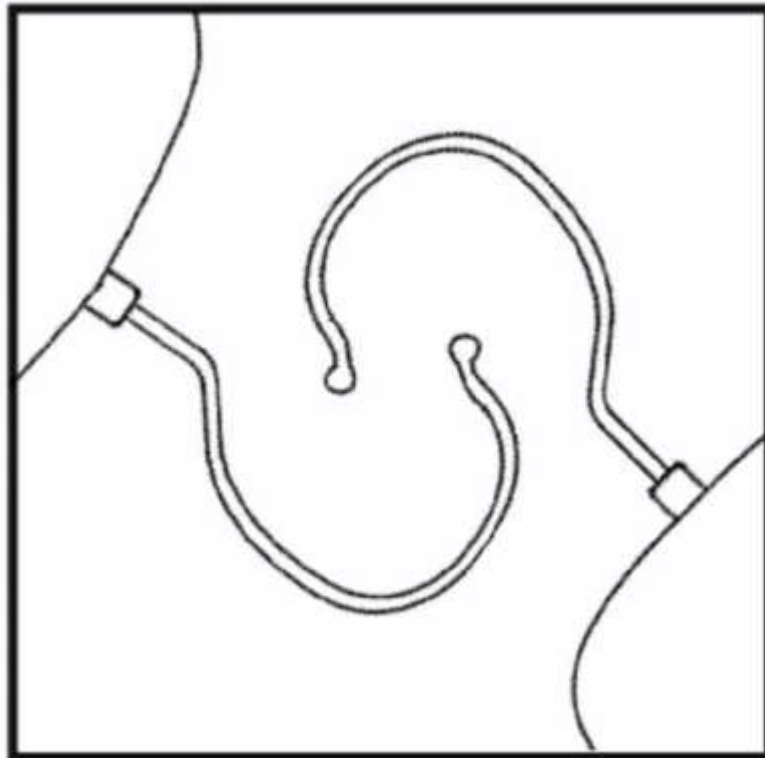

**TIC** GROUP  
Retail Accessories

a division of

**PACT**  
GROUP

## ~" + D67D@

---

Suppliers must place orders by accessing the TIC website and following the prompts. To use the online ordering system, suppliers must be registered with TIC, and issued with a password. All orders placed online will be automatically confirmed by return email. It is a David Jones requirement, that when placing orders, Suppliers are to nominate the volume required by David Jones. † >AD67DE I ;>47 DAG@76 GB FA F. 7 @73D7EF8G>53DFA@

~" † GEFDB>3° \* 7I 273>3@° #;<° 3@ , 35;85 Ž3E;@

Orders can only be placed on-line by logging on to [www.ticgroup.com.au](http://www.ticgroup.com.au) click onto Retail Accessories and follow the prompts. All orders placed online will be automatically confirmed by return email.

Lead Times – all orders will be processed and dispatched within 2 working days.

Upon receipt of this package it is advised that Australian manufacturers and Australian based importers need to apply to TIC for a credit application form.

~" † ž : ;@° AF. 7D† E;3@3@ " GDAB73 @5AG@D7E

Orders should be placed on – line by logging on to [www.ticgroupasia.com](http://www.ticgroupasia.com) click onto Retail Accessories and follow the prompts. All orders placed online will be automatically confirmed by return email.

Lead Times: On receipt of all approved Customs documentation from the customs office, orders will be processed for dispatch I ;F. ;@/ I AD-;@ 63KE~

& BADB@F\* AF7 8ADž : ;@ A@Kfi ž : ;@7E7 ž GEFA? E! A5G? 7@BFA@EGBBADF;@ F. 7 7JBADFA8F. 7E7 : 3@7DE° ? GEFEGBB>76 FA / & 478AD7 AD67DE 53@47 BDA57EE76~

# 1 " Ž 0 . / + ) .

---

## 1 " † GEFD>3 3 @ \* 7I 273>3 @ Ž GEFA? E - 7CG;D? 7 @E:

Importers should ensure that the hanger cost is shown separately on Import Invoices and as a separate entry on the Import Duty Warrant under tariff item 3924-90-00 at 5% duty. All apparel merchandise invoices must include a declaration as per the following example:

" J3? B>7fi

The unit cost of hangers, of Chinese origin, included on order 1234567 is US\$0.15 each and this cost is included in the invoice cost per unit of the product."

If you have any queries, please contact the TIC (Retail Accessories) office.

## 1 " Ž : ; @

Upon receipt of orders at TIC, a fax, accompanied by a telephone call is made to Suppliers, requesting a copy of their Customs Documentation.

From receipt of all Customs documentation goods are dispatched within 3 working days.

## 1 7 + F 7D5AG @ D7E

For hangers imported into other countries it is the responsibility of the Importer to ensure correct customs procedures are followed.



fi" / & \$ - + 0 , ž + \* / † ž / & # + - ) † / & \*

---

**/ & \$ DAGB L ) 7AAGD@ + 8857 ~%736 + 8857**

214 Blackshaws Road  
Altona North VIC Australia 3025  
Telephone: (03) 9393 3737  
Toll Free: 1800 790 110  
Facsimile Number: (03) 9392 2332  
Email: [: 3@7DE F59DAGB5A? 3G](mailto:3@7DE F59DAGB5A? 3G)  
Web: [I I I F59DAGB5A? 3G](http:// F59DAGB5A? 3G)

All deliveries are ex TIC Melbourne National Warehouse.  
All invoices will be issued in AUD\$ currency.

**/ & \$ DAGB L %A@ ' A@ + 8857**

Unit 3, 29/F Saxon Tower,  
7 Cheung Shun Street,  
Lai Chi Kok, KOWLOON,  
HONG KONG  
Telephone: (852) 2148 3685  
Facsimile Number: (852) 2148 3085  
Email: [: 3@7DE: =L F59DAGB3E:3 5A?](mailto:3@7DE: =L F59DAGB3E:3 5A?)  
Web: [I I I F59DAGB3E:3 5A?](http:// F59DAGB3E:3 5A?)

**/ & \$ DAGBL\* ;@4A + 8857 ~ 7BD7E7@76 4K\* ;@4A 1G@;@ / D67 ž A ( R**

Block 3, No 15 Chuang Ye Da Dao  
West District of Free Trade Zone, Beilun  
Ningbo, China  
Telephone: 86 574 2687 3733  
Facsimile Number: 86 574 8682 3880  
Email: [: 3@7DE5@ F59DAGB3E:3 5A?](mailto:3@7DE5@ F59DAGB3E:3 5A?)  
Web: [I I I F59DAGB3E:3 5A?](http:// F59DAGB3E:3 5A?)

**/ & \$ DAGBL. : 3@: 3; + 8857**

Unit E, 17/Floor, Hengji Plaza  
No 99 East Huaihai Road  
Huangpu District  
Shanghai, 200021, China  
Telephone: 86 21 6386 0808  
Facsimile Number: 86 21 6386 9533  
Email: [: 3@7DE5@ F59DAGB3E:3 5A?](mailto:3@7DE5@ F59DAGB3E:3 5A?)  
Web: [I I I F59DAGB3E:3 5A?](http:// F59DAGB3E:3 5A?)

All invoices will be issued in US\$ currency.



**TIC GROUP LTD GARMENT HANGERS  
PRE - APPROVED BY DAVID JONES**

**HANGER INDEX**

<b>Category</b>	<b>Code</b>	<b>Colour</b>	
<b>Tops</b>	4466WDJ 4471WDJ 4467WDJ 4468WDJ 4455DJ 4456DJ 4470SDJ 4470DJ 4489DJ 4475DJ	White White White White Black Black Black Black Black Black	250 mm Children's Upper Body 300 mm Children's Upper Body 360 mm Children's Upper Body 410 mm Adult's Upper Body 410 mm Adult's Upper Body 460 mm Adult's Upper Body 410 mm Adult's Knitwear 460 mm Adult's Knitwear 430 mm Adult's Jacket 460 mm Adult's Jacket
<b>Bottoms</b>	4433LCDJ 4427WDJ 4472DJ 4472WDJ 4473DJ 4473WDJ 4429DJ	Clear White Black White Black White Black	300 mm Adult's Lower Body 190 mm Children's Bottom Body 280 mm Children's Bottom Body 280 mm Children's Bottom Body 320 mm Adult's Bottom Body 320 mm Adult's Bottom Body 360 mm Adult's Bottom Body
<b>Sleepwear</b>	4495CDJ 4496CDJ	Clear Clear	410 mm Adult's Sleepwear 460 mm Adult's Sleepwear
<b>Lingerie</b>	4437CDJ 4436CDJ	Clear Clear	210mm Lingerie Hanger 260mm Lingerie Hanger
<b>Access.</b>	4402CL/1 4402DJ/1 4402CDJ/1	Clear Black Clear	Hook & Loop Hook & Loop Hook & Loop
<b>Price List</b>			

**Category** • Children

**Application** • Shirts, Tops, Dresses, Knitwear, Jackets,  
Jump Suits, Overalls, Sleepwear, Spencers, Camisoles and Slips

C O D E

4466WDJ

4471WDJ

4468WDJ

4467WDJ

Top  
White Hanger

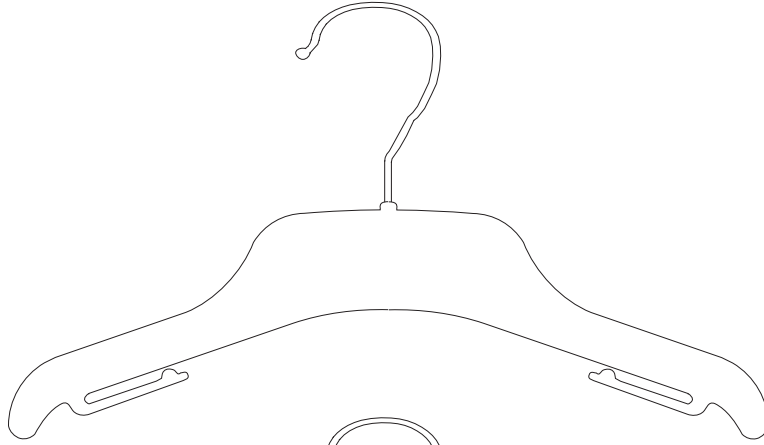

**4466WDJ**  
**250mm**

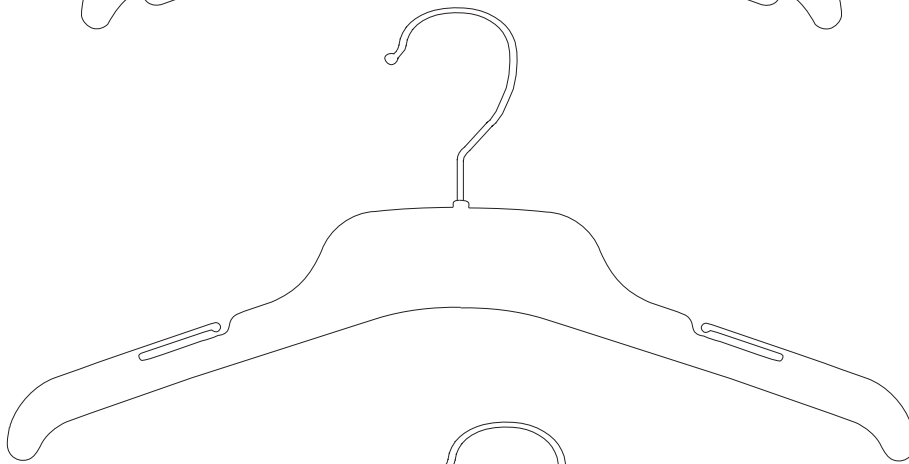

**4471WDJ**  
**300mm**

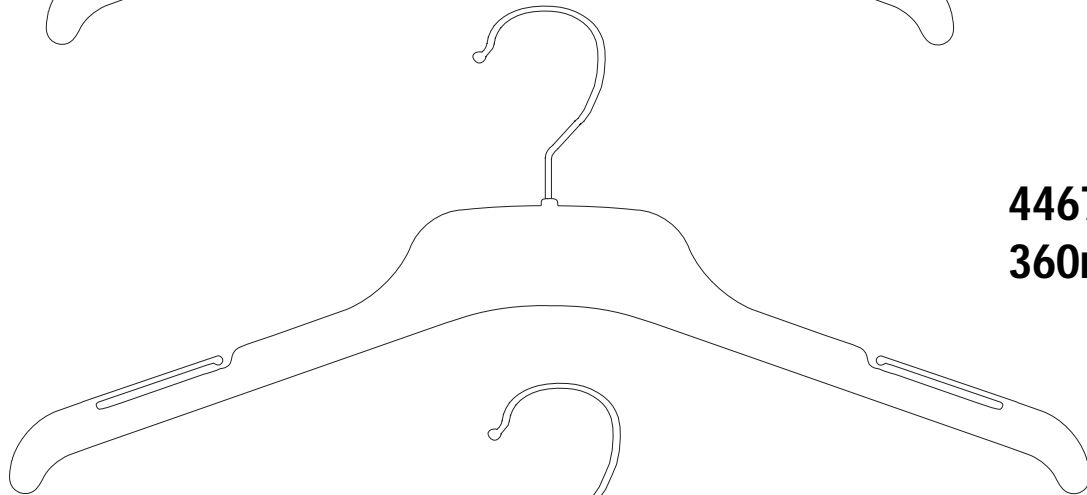

**4467WDJ**  
**360mm**

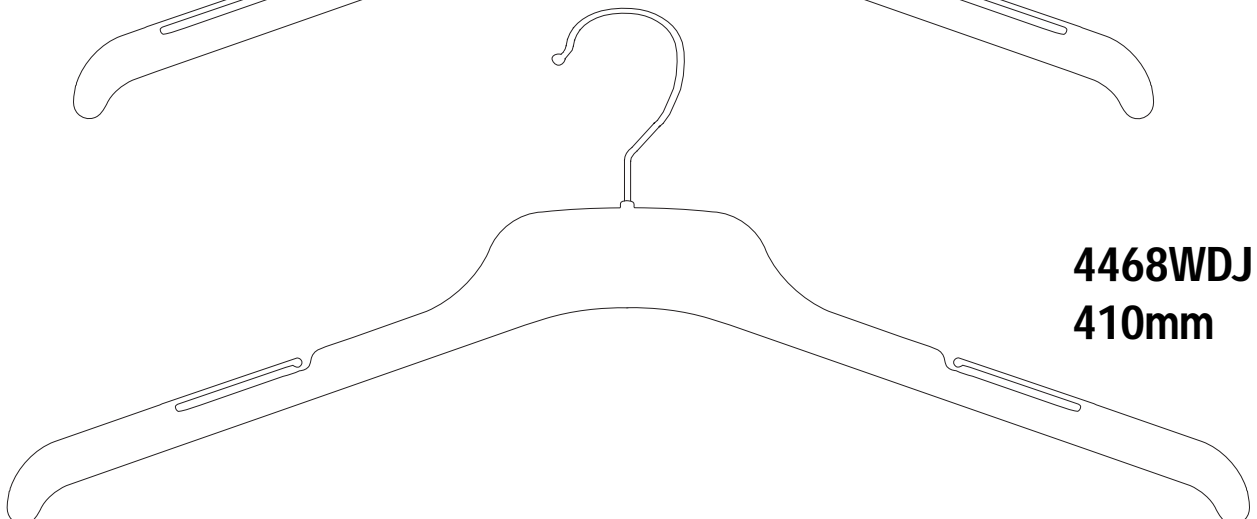

**4468WDJ**  
**410mm**

C O D E

**Category** • Adults

**Application** • Shirts, Tops (assorted), Dresses,  
Knitwear, Jackets

**4455DJ**

**4456DJ**

**Top Hangers**

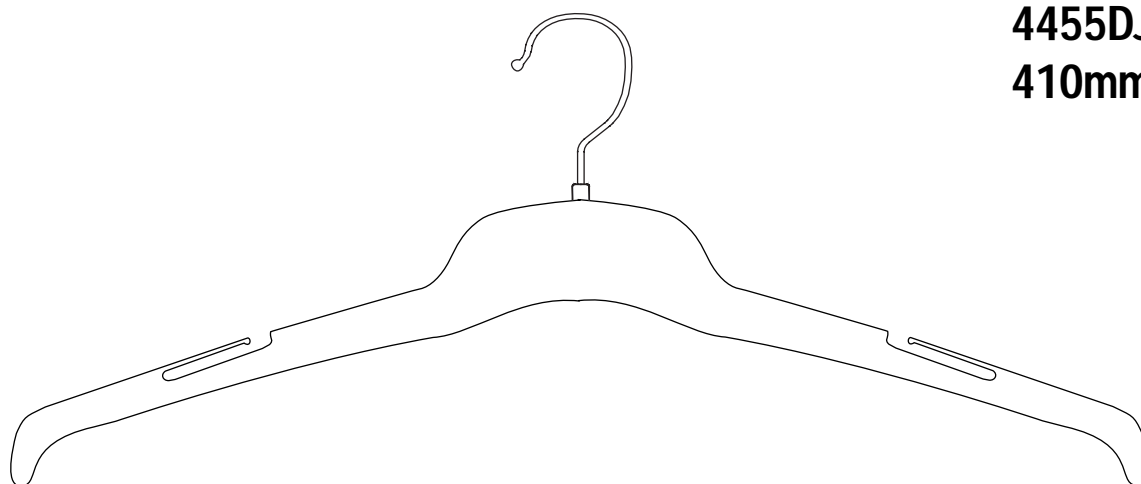

**4455DJ**  
**410mm**

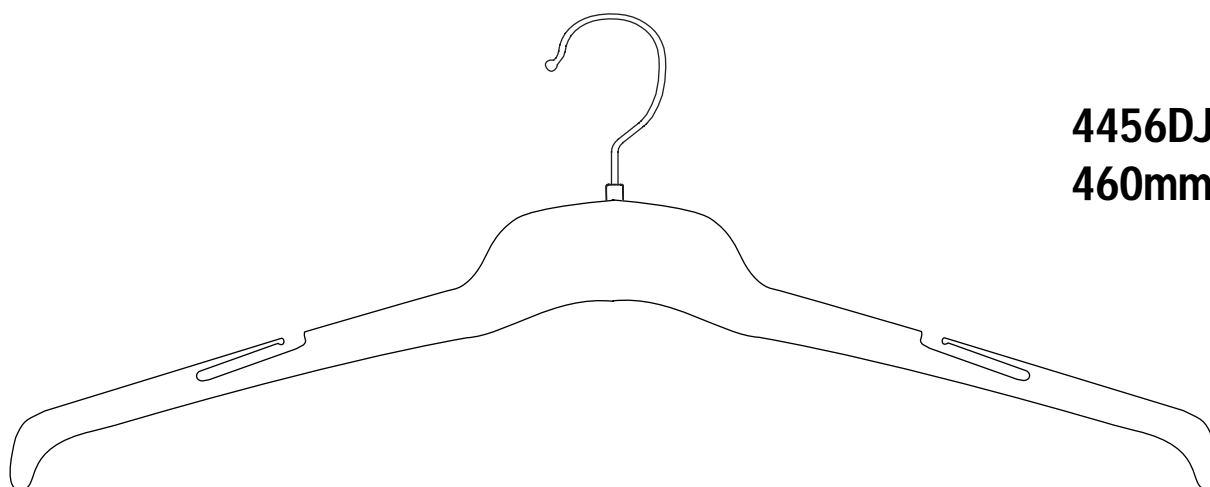

**4456DJ**  
**460mm**



Category • Adults

Application • Jackets

C O D E

4489DJ

4475DJ

Jacket Hangers

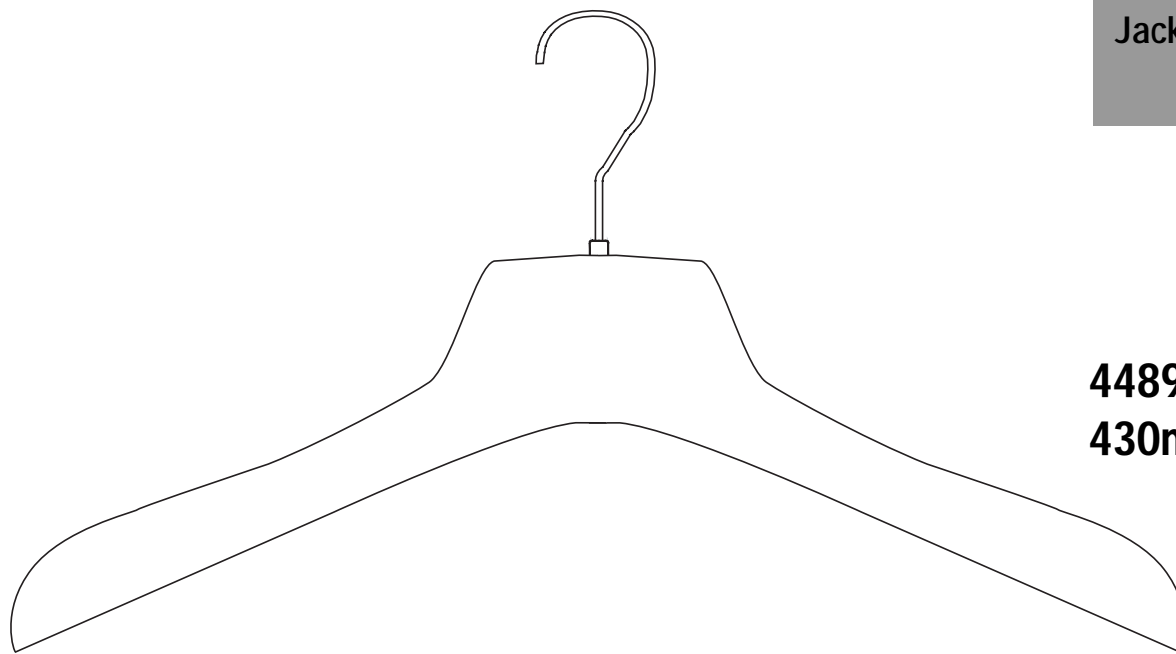

4489DJ  
430mm

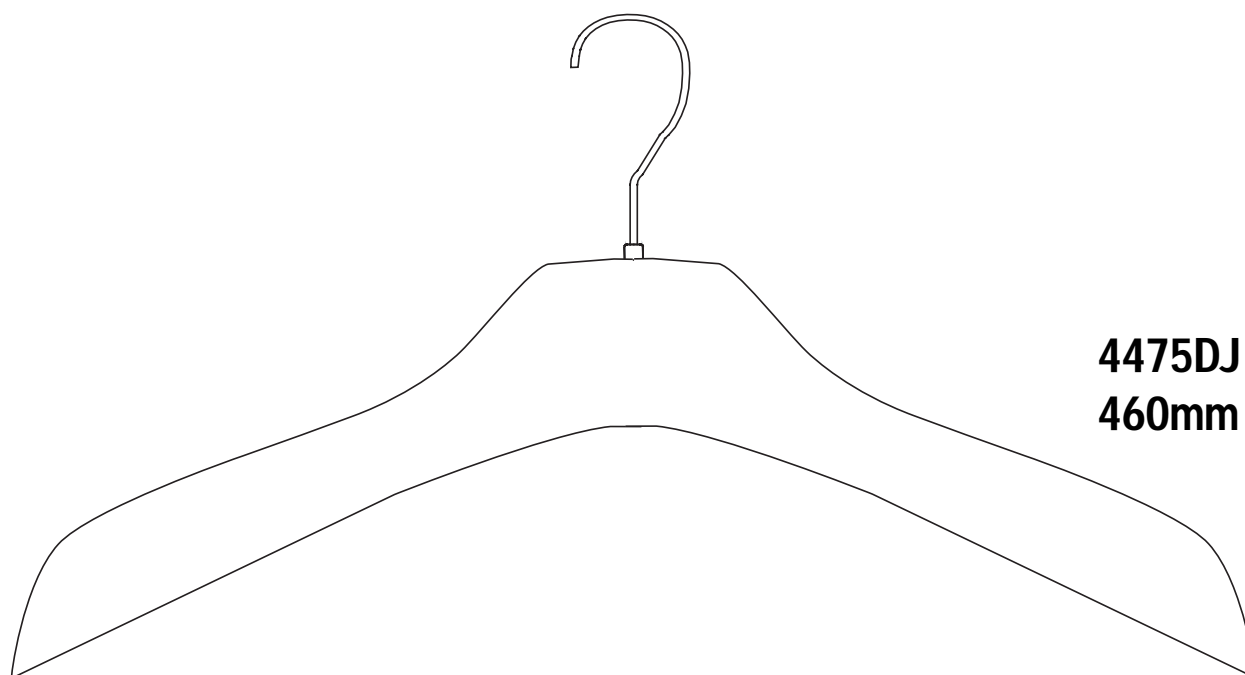

4475DJ  
460mm

Category • Adult

Application • Knitwear

C O D E

4470SDJ

4470DJ

Top Knitwear  
Hangers

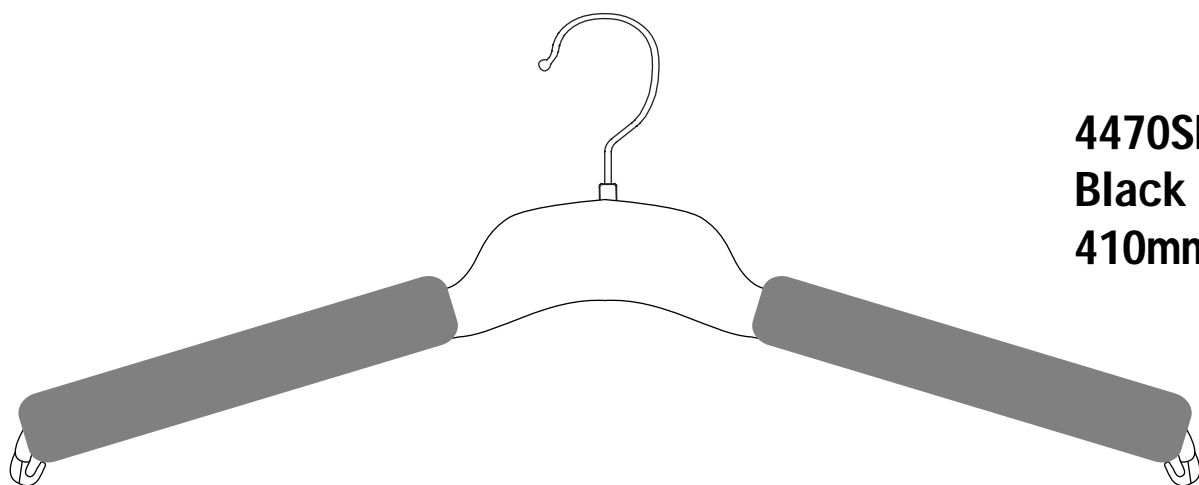

4470SDJ  
Black  
410mm

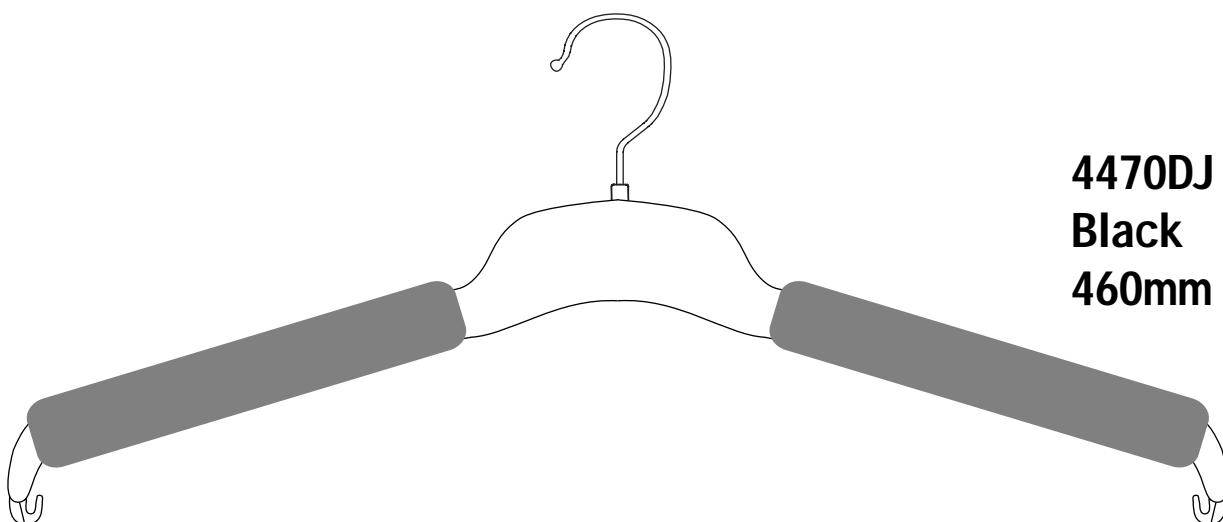

4470DJ  
Black  
460mm

**Category** • Adults and Childrenswear

**Application** • Pants, Skirts, Shorts and Sets

**4472DJ**  
**4473DJ**

**Bottom Hanger**  
**Low Profile**

**4472DJ**  
**Black**  
**280mm**

**4472WDJ**  
**White**  
**280mm**

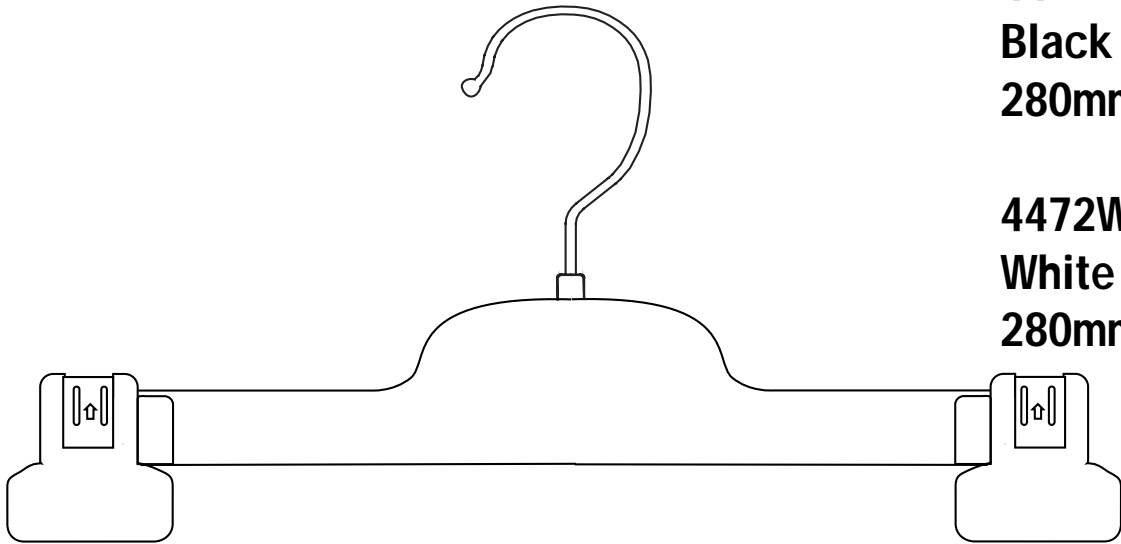

**4473DJ**  
**Black**  
**320mm**

**4473WDJ**  
**White**  
**320mm**

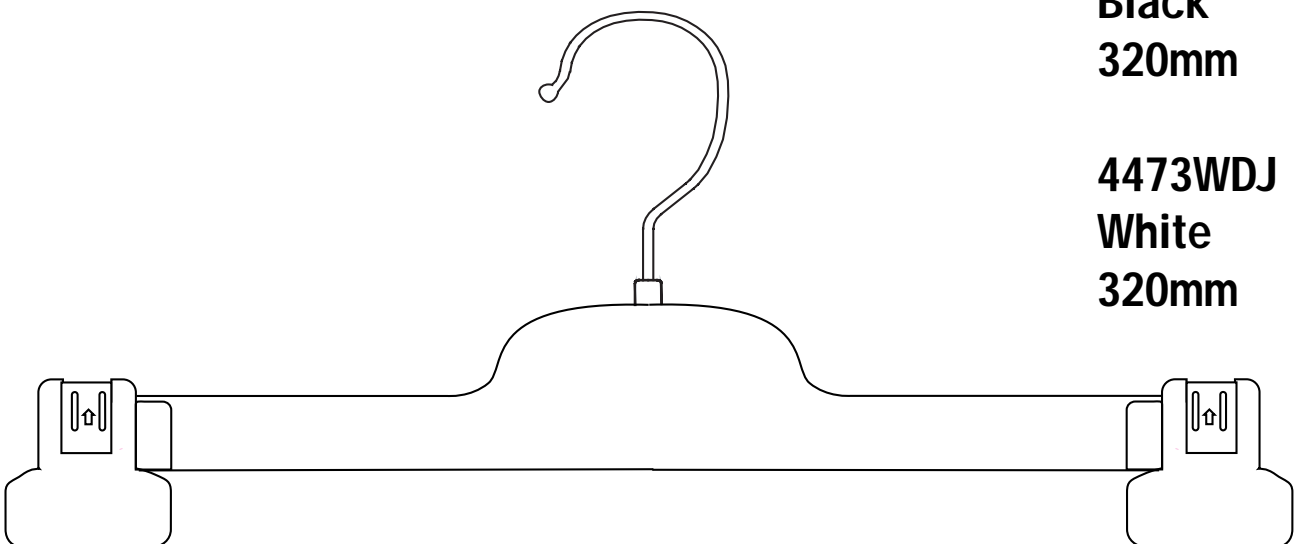

C O D E

Category • Adult

Application • Pants, Skirts, Shorts and Sets

4429DJ

Bottom  
Movable Clip  
Hanger

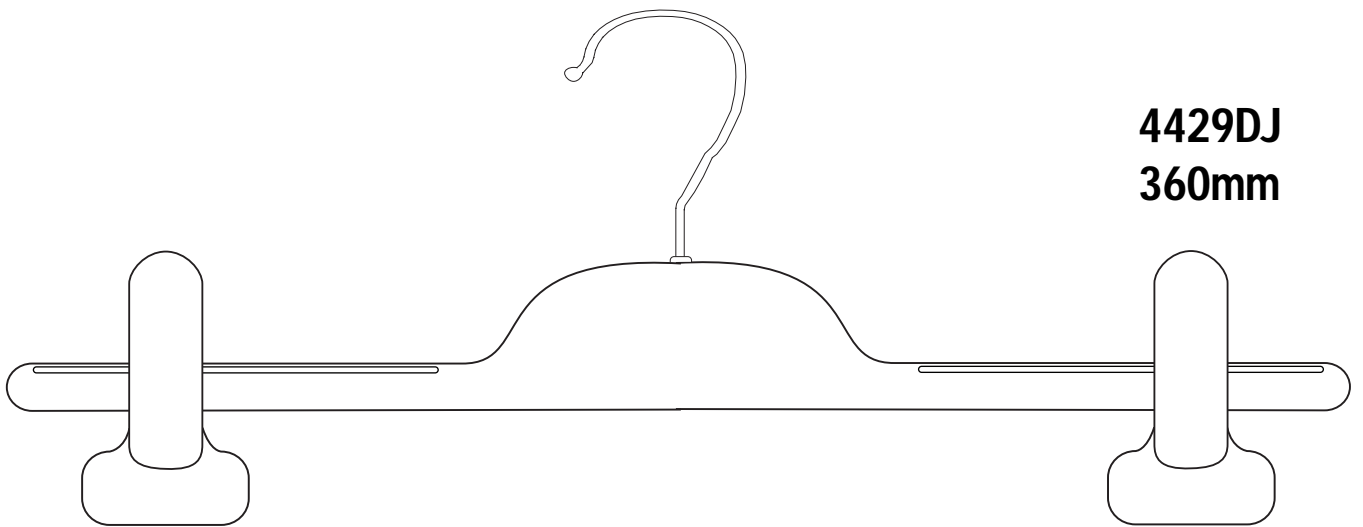

4429DJ  
360mm

C O D E

Category • Adults

Application • Pants, Skirts, Shorts and Sets

4433LCDJ

Bottom  
Hanger  
Low Profile

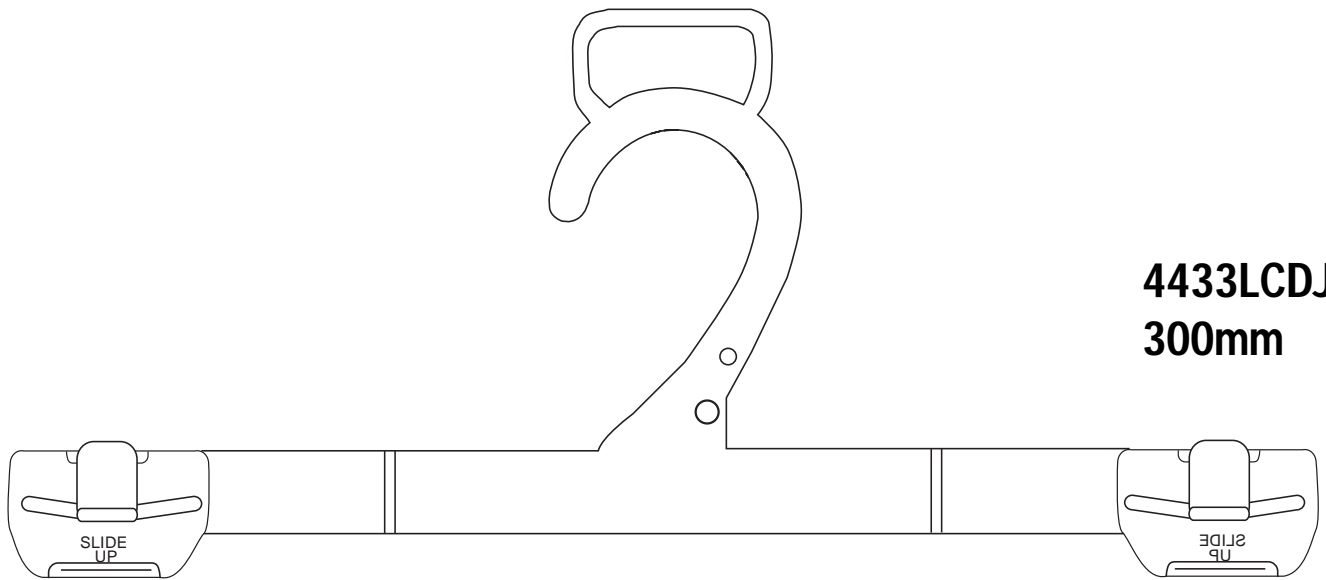

4433LCDJ  
300mm

**Category** • Childrens

**Application** • Pants, Skirts, Shorts and Sets

C O D E

4427WDJ

Bottom Hanger

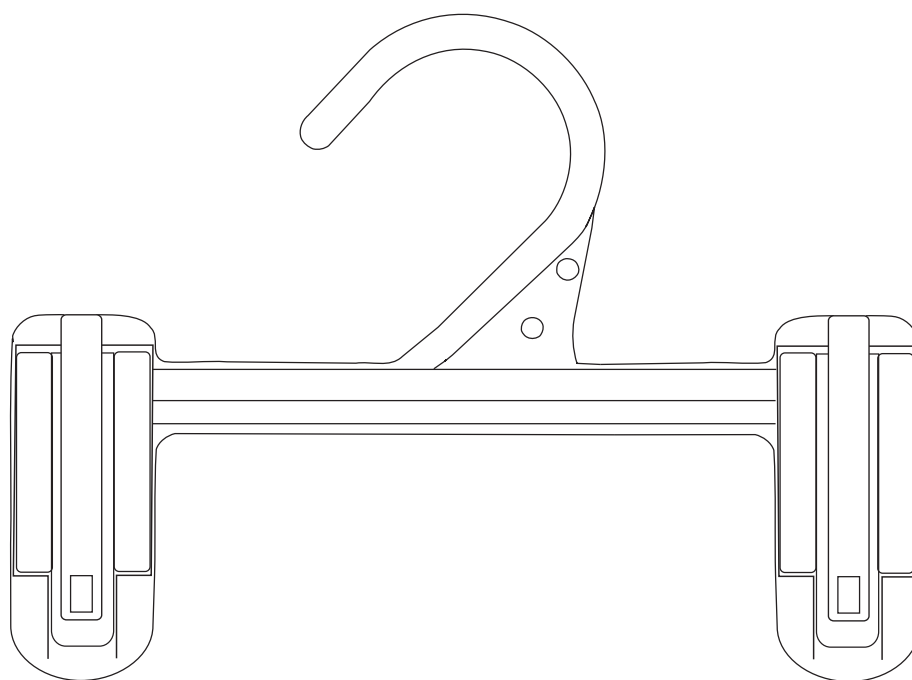

4427WDJ  
190mm

Category • Adult

Application • Sleepwear

C O D E

4495CDJ

4496CDJ

Top Clear  
Hanger

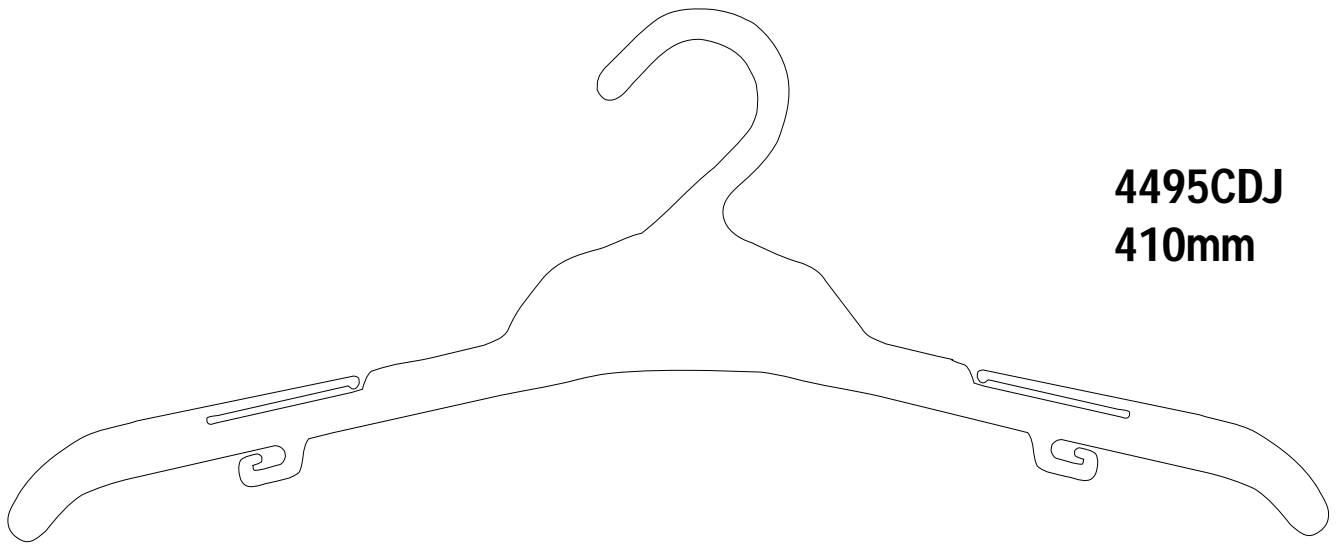

**4495CDJ**  
**410mm**

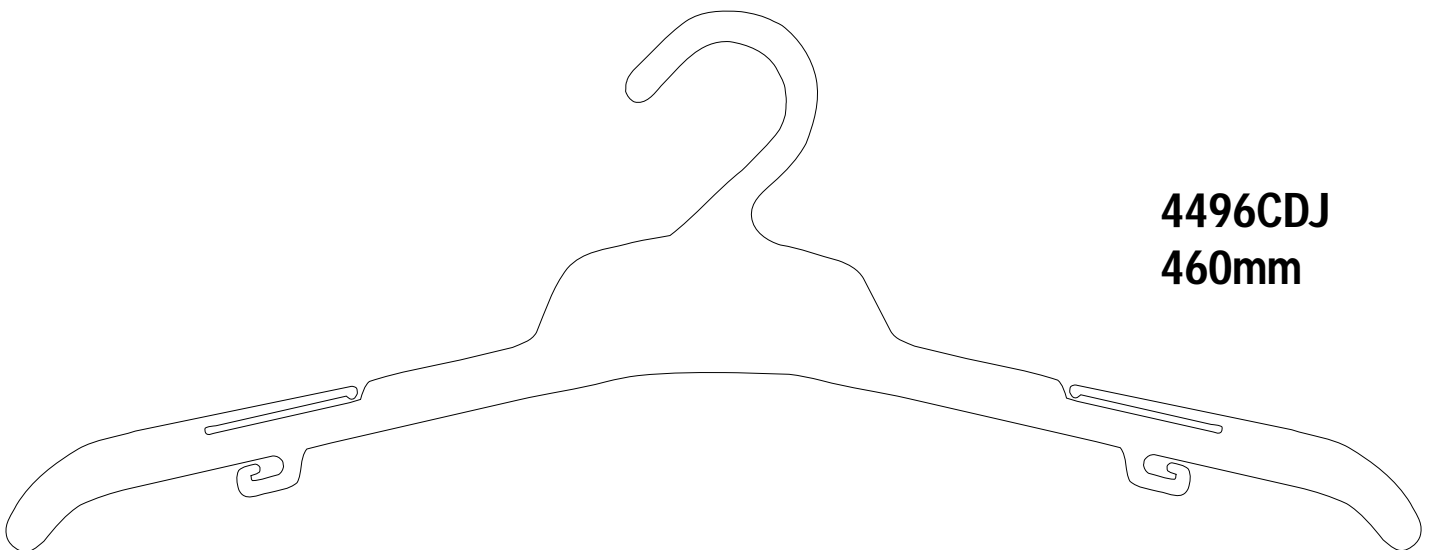

**4496CDJ**  
**460mm**

C O D E

**Category** • Children and Adults

**Application** • Briefs, Bras, Camisoles and Underwear Sets

**4437CDJ**  
**4436CDJ**

**Adult &  
Childrens Brief  
and Lingerie  
Hanger**

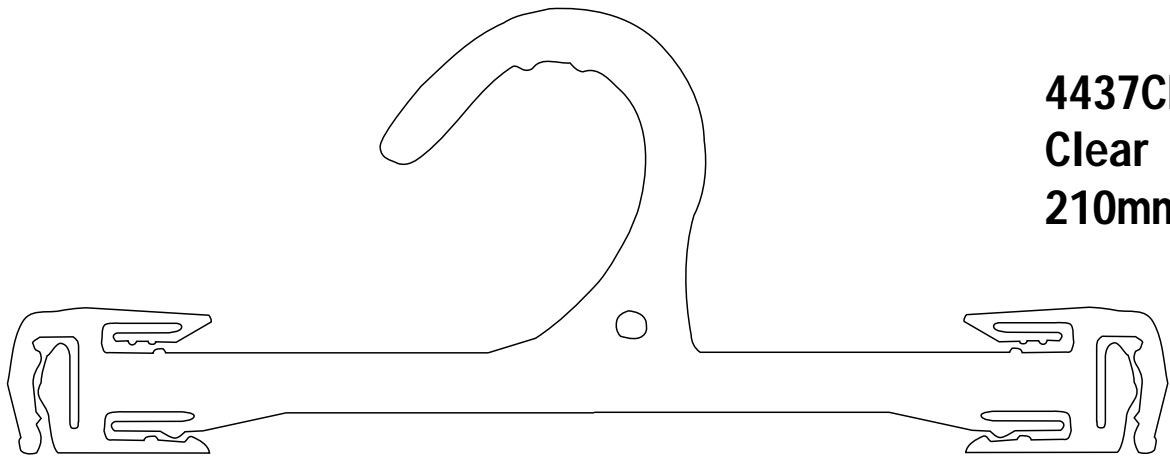

**4437CDJ**  
**Clear**  
**210mm**

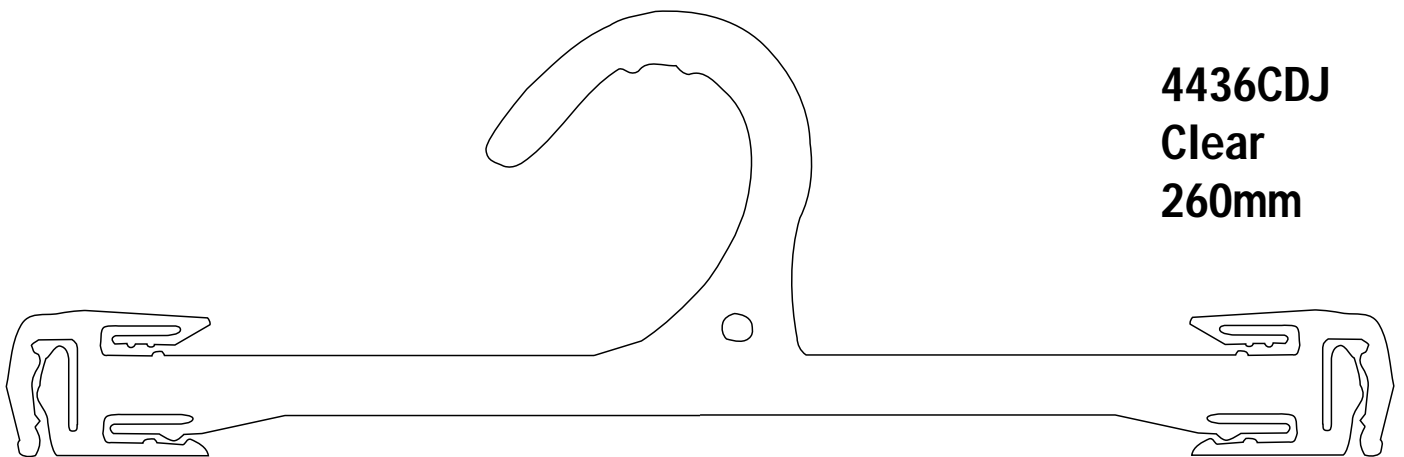

**4436CDJ**  
**Clear**  
**260mm**



C O D E

**Category** • Children and Adults

**Application** • Totally interchangeable for all top and bottom hangers and universal accessory hook

**AC69CR**  
**4402CL/1**  
**4402DJ/1**  
**CL4418BL**

**Hook and Loop**  
**Universal**  
**Accessory Hook**

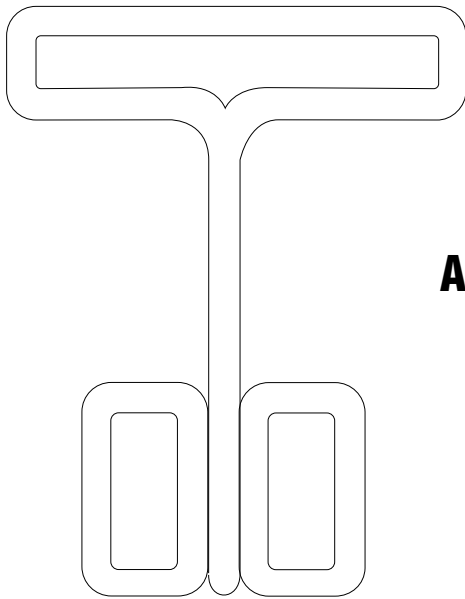

**AC69CR**

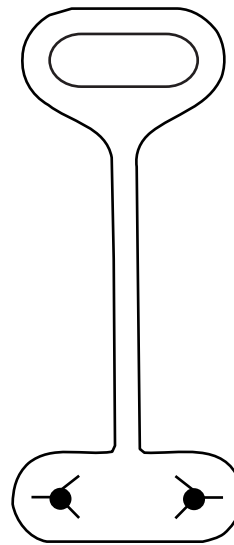

**4402DJ/1**  
**4402CDJ/1**



**CL4418BL**